

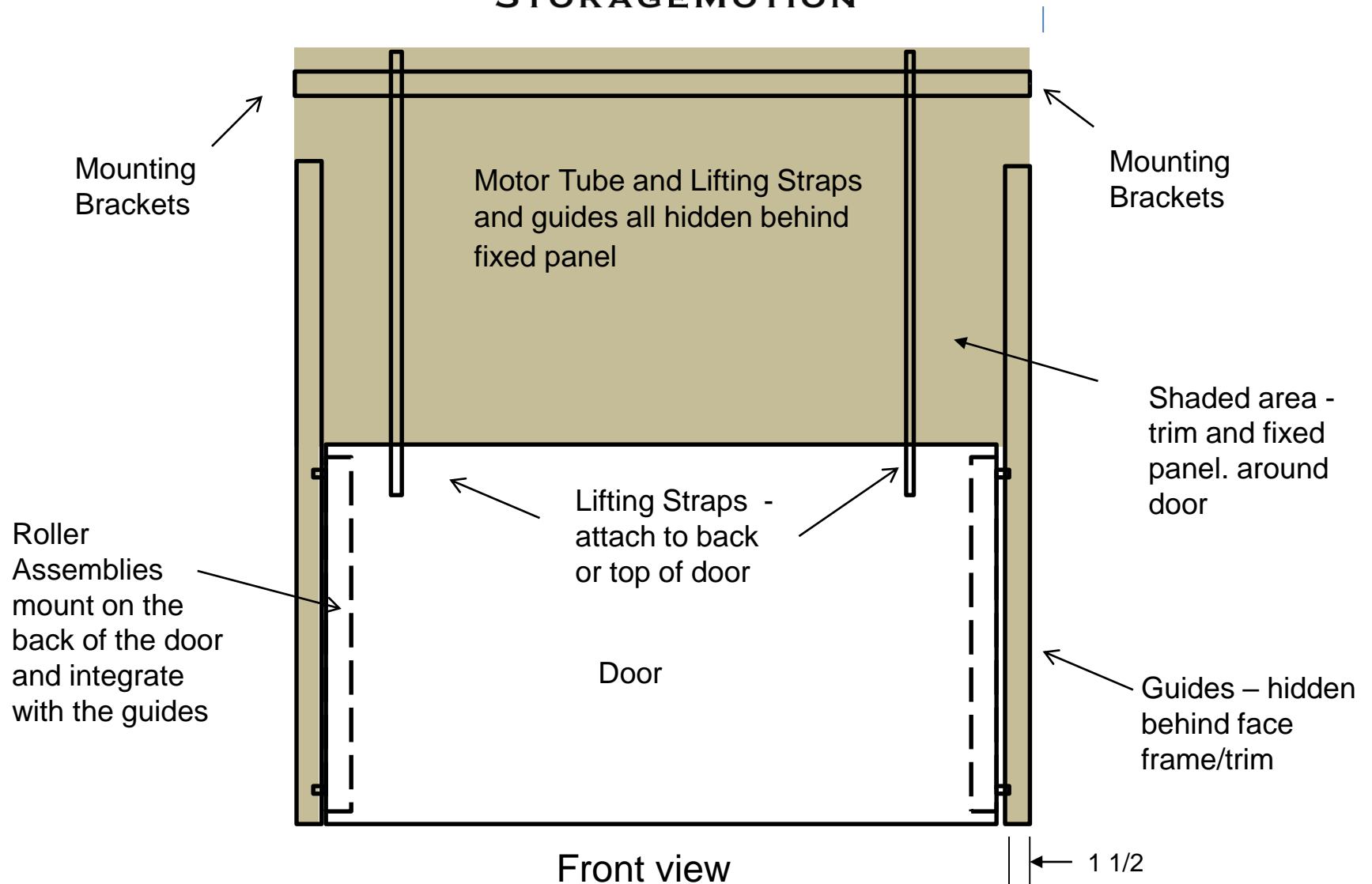

Single Panel Automated Door Drive - Straight Up and Down

- Typically used for , appliance garages, safes, pantries ,TVs boardrooms etc.
- Door only moves straight up and down.
- The door drive is a motor tube with lifting straps. Starting and stopping points for the door are set at installation.
- Doors are not included. System includes tracks , motor drive and controls.
- Controls available include IR remote , RFQ remote, low voltage switch, 120 volt switch and Home Automation Integration
- Custom guides and roller assemblies available



Top view

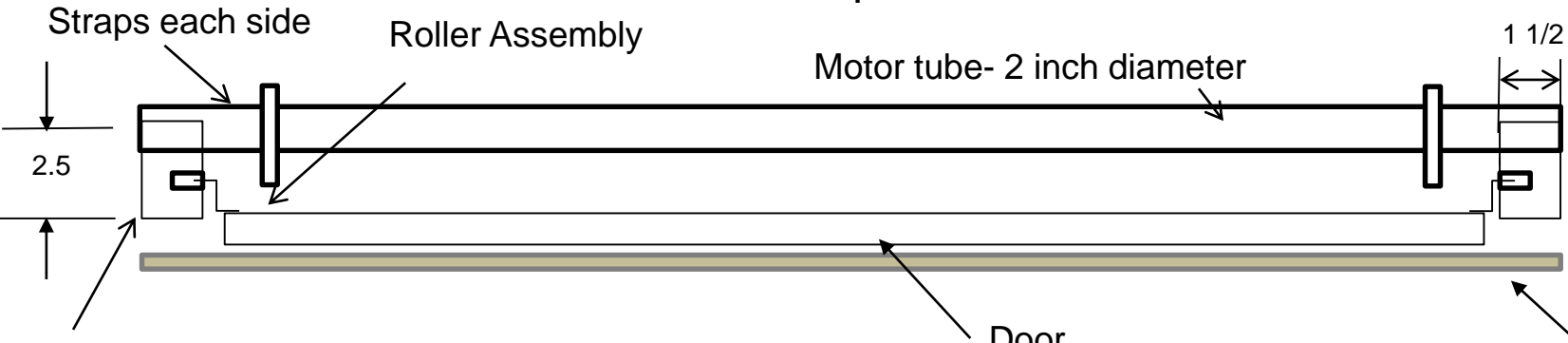

Guides/tracks on each end.

4" minimum

Motor Tube - 2 inch dia

Motor Tube – can also be placed lower or anywhere it can implement proper leverage

Fixed panel and trim

OPEN

CLOSED

Side View

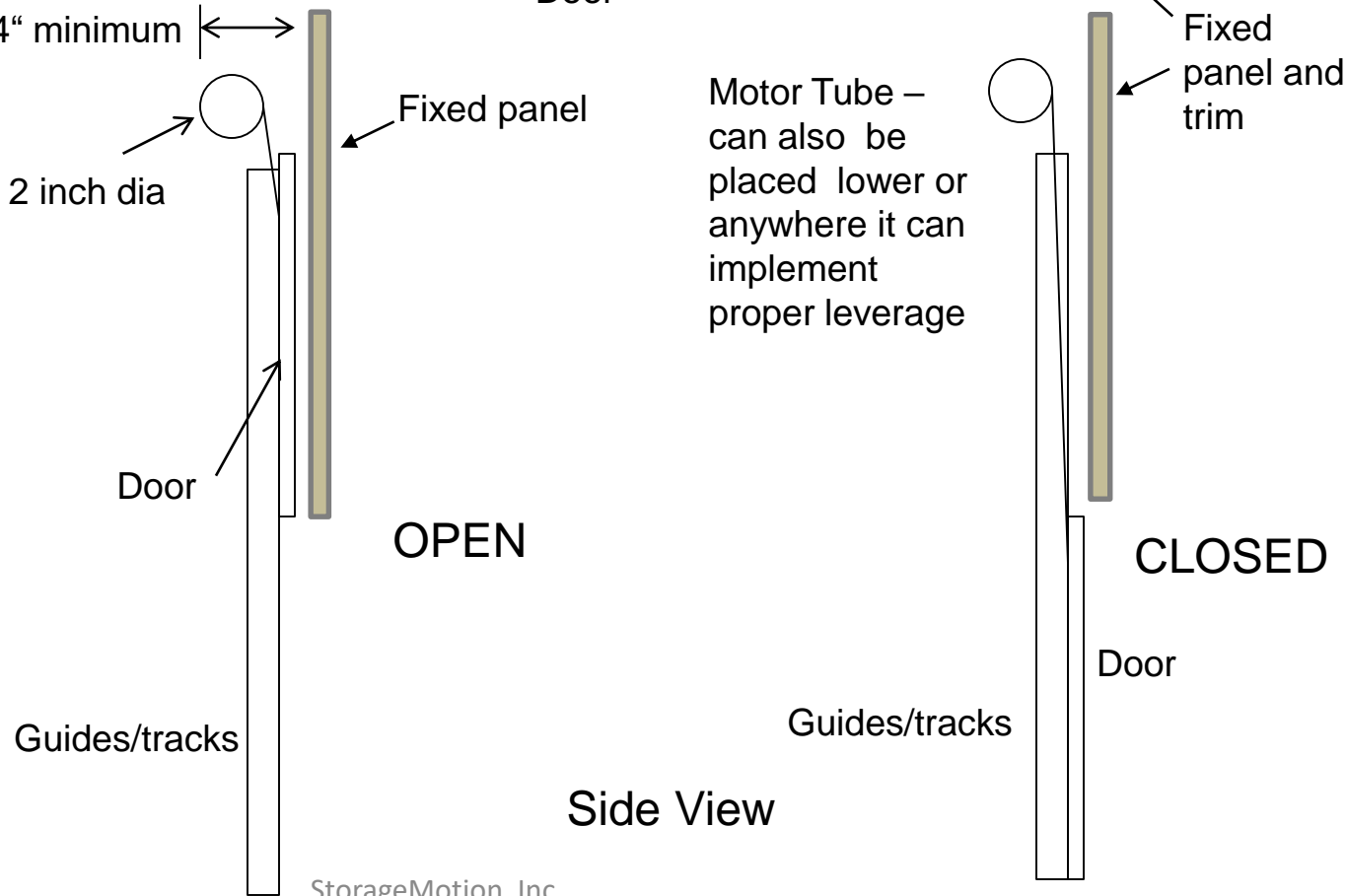



STORAGEMOTION^{INC.}
Guides and Roller Assembly

Top View

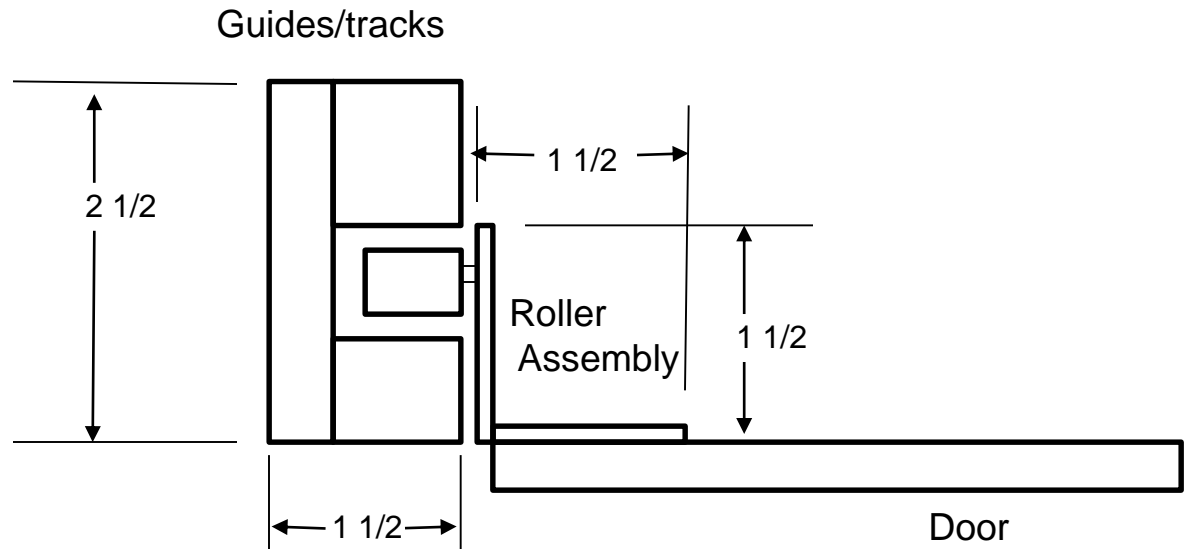

NOTE: Front of guides will align with the back of the door

NOTE: Custom roller assembly designs also available



STORAGEMOTION^{INC.}

Guides and Roller Assembly

Guides/tracks

Roller Assembly

Length of Guides is typically twice height of the door plus a few inches



Length of Roller Assembly depends on height of the door



Side view

Motor Tube Mounting Brackets

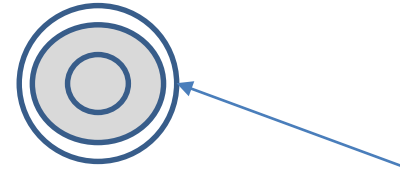
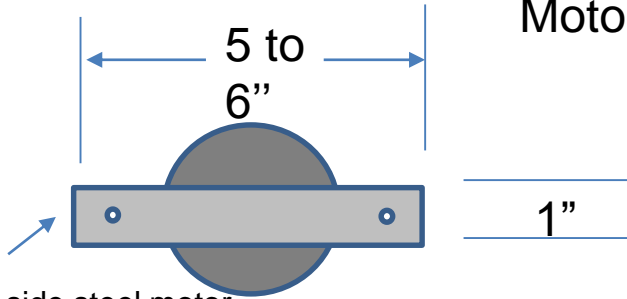

Right side steel motor
brace Secures with 2 to 4
screws

Side View
Motor End

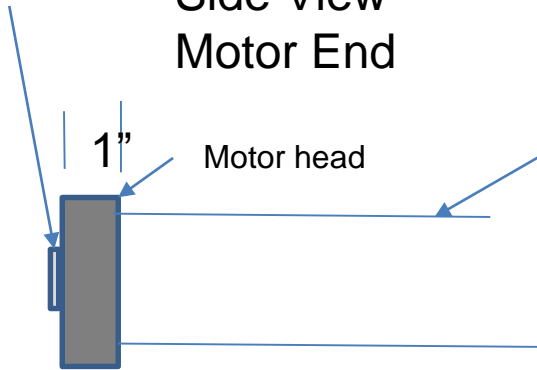

Front View
Motor end

Side View NON -
Motor end

Motor tube - 2 " dia

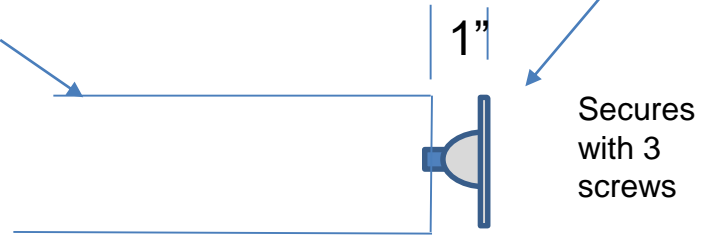

Front View NON -
Motor end

Lifting Strap brackets

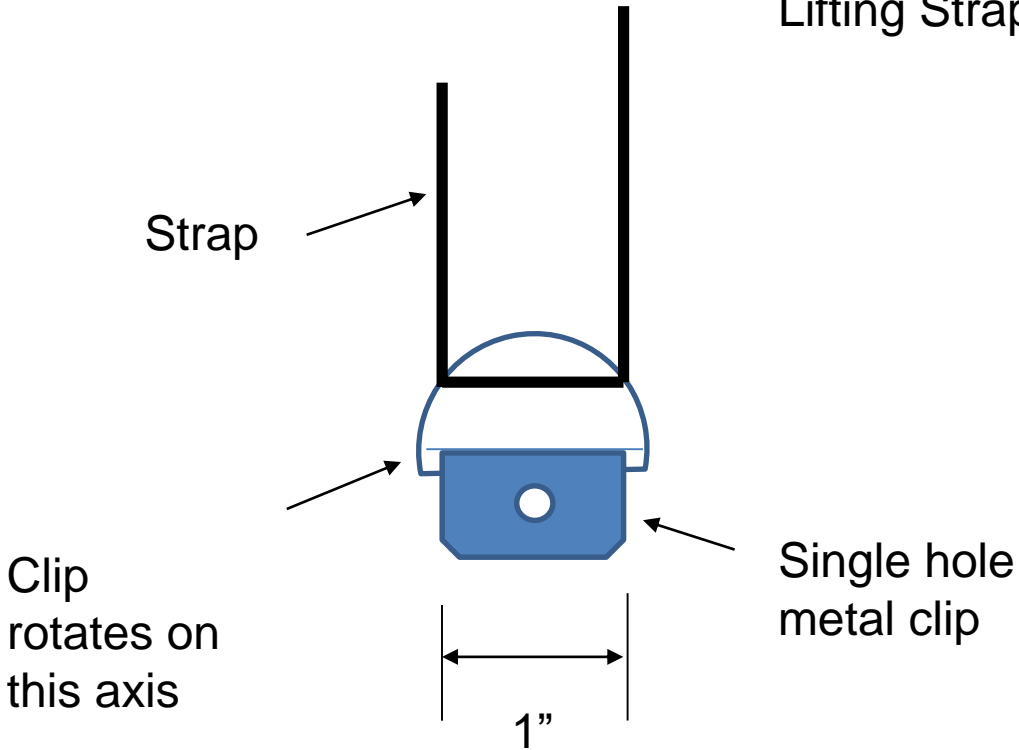

Top view – Optional Approach

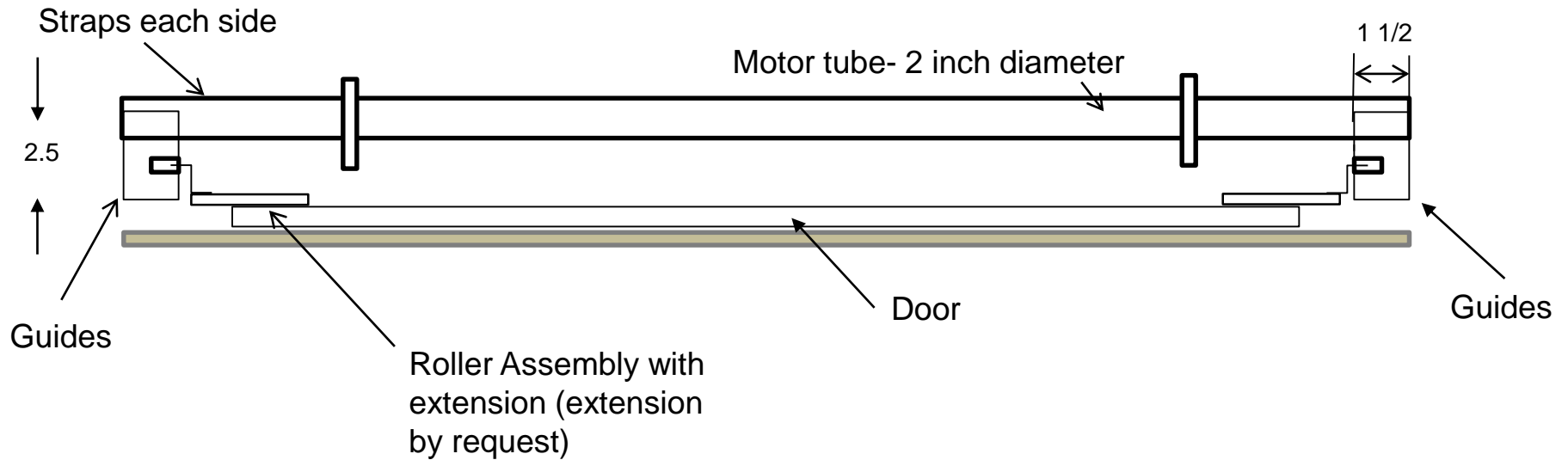

This approach allows the guides to be moved out right and left to help further conceal them