



Automated Wardrobe Lift Installation Instructions
Standard

Tips for successful installation

1. When mounting the rotating arms, make sure you allow for the arms at the clothes rail position to be slightly forward (½ inch) when in the up position.
2. Ensure rotating arms when mounted are properly aligned with each other and with the motor tube lifting straps.
3. To ensure correct arm positioning when setting the motor limits ensure that clothes rail is loaded.
4. If multiple wardrobe lift units are included , each wireless wall switch (transmitter) is assigned a motor at the factory and should be marked with a capital letter on the transmitter bag and on the motor tube.
5. The Left and Right side are determined by facing the closet from the front and looking into the closet.

Installation Warning

- 1. If NOT properly installed or adjusted, the Automated WardrobeLift™ may get stuck and then come down suddenly! DO NOT POSITION THE Automated WardrobeLift™ IN THE DOWN POSITION LOWER THEN THE TOP OF THE USER'S HEAD. IF THIS INSTRUCTION IS NOT FOLLOWED, INJURY MAY RESULT!***
- 2. If The Automated WardrobeLift™ is installed behind cabinet/closet doors, ensure that the wireless wall switch is mounted inside the enclosure.***
- 3. Do not cut or saw to the left of the set screws on the motor tube OR within 2 inches to the right. Motor is inside of the tube with cord on the left.***

1. Attach LH and RH Mounting Box to the cabinet sides using the #4x20mm Flat Head Screws. MAKE SURE THAT EACH SIDE IS PROPERLY ALIGNED WITH EACH OTHER. See Fig 1,2 and 3 and photo 1 . The longer screws are to be used at the bottom of the mounting box.
2. Mount the telescoping clothes rail by attaching the side supports for the clothes rail using two M8x35mm Screws . Use the hex key to loosely tighten.
3. Adjust the telescoping rail to proper length and twist to lock it. After adjusted to desired width remove the side supports from step 2 and add the clothes pole. **The main outer clothes pole must be cut to the correct length before it is added. It BUTTS up against the side supports and goes over the telescoping rail.** Replace side supports and Re-tighten the M8 x35 Screws.
4. Lift the arms manually and ensure there is NO BINDING or scraping and that the arms move freely at all times.
5. Measure the closet opening (see Fig 1)The metal motor tube needs to be cut 1 1/2 inches less than the closet opening(inside dimension). See photo 2 for where to hold the measuring tape. Do not include the motor head when measuring the tube.
6. Insert right side end cap into the metal tube and place white round plastic idler bearing onto right side end cap. Do not yet mount tube.
7. Mount right side strap with the strap clip and the small machine screw that is supplied. See photo 3. Drill through the tube with 3/32 bit and attach the strap with the screw so that the tape on the strap is directly across from the tape on the left side strap. This ensures that the straps are the same length when lifting the rotating arms. Do not try to drill through the lifting strap material as this is not necessary. The strap needs to be mounted about ¼ from the right end of the tube (see Photo 4) and the “X” on the tape needs to be against the motor tube so that the strap clip on the other end is positioned correctly.

8. Mount RIGHT side idler bracket for the motor tube using the 2 #10 screws supplied on right hand side at the top. Use the sticky foam to assist in placement of the bracket and to reduce vibration. See Fig 2 and photo 6 for where to position. **The motor must be on the left side for lifting straps to be correct as they must lift from the top of the tube as opposed to the bottom of the tube**
9. Mount LEFT side bracket with 2 # 10 screws provided, Use the sticky foam to assist in placement of the bracket and to reduce vibration. . See Fig 3 and photo 6 for where to position.
10. Place tube with motor into square opening in left bracket and then place right side tube into right side bracket (SEE photo 4 and 5) Make sure that straps are coming from the top of the tube as opposed to the bottom of the tube. Add the cotter pin to secure the motor in the left side bracket.
11. Ensure that motor tube is parallel with what will be the position of the clothes rod. Motor side of tube with cord must be on the left side
12. Manually unwrap the straps and attach to the predrilled mounting holes at the end of each rotating arm using the #6 machine screws and nuts . **Do this while the arms are in the complete down position (Horizontal). Make sure that strap clips are secure and that straps are NOT twisted and that they line up with the arms.** See Fig 4 for strap clip position.
13. If not being hardwired by an electrician, connect the plug to the motor cord. The brass screw goes with the black wire, the silver screw with the white wire and the green screw head goes with the green wire (ground).
14. Plug in the unit . The top button on the transmitter is for UP, the middle button is for STOP, and the bottom button is for DOWN. Ensure transmitter matches for the motor.
15. **Ensure that the lifting straps and the rotating arms are in alignment when the rotating arms are operating.**



CONTACT PHONE - 704 746 3700

- 16 Set the limits Raise black cover to expose very small left and right keys. (see photo 7 and 8)
 1. SET DOWN LIMIT. Press left key once then press DOWN button once... Now UP or DOWN buttons should respond momentarily. Use them to place rotating arm at its resting point with no slack in straps. Select the stop button (center button) once to complete the setting
 2. SET UP LIMIT. Press left key once then press UP button once.... Now UP or DOWN buttons should respond momentarily. **Use them to locate the rotating arms just slightly forward (½ inch).** Select the stop button (center button) once to complete the setting.

Notes – a) When entering in the limits settings you only have 5 seconds to BEGIN to command the motor after pressing the left key. b) In the process of adjustment, any coincidental press to the stop key will be considered as the limit setting is complete .To restart you must press the LEFT key again. C) LIMITS CAN BE RESET ANYTIME DURING THE LIFE OF THE PRODUCT.

- 17 Test the unit. If lifting straps have different levels of slack, the right or NON motor side strap can be adjusted by setting a new securing screw position. **Ensure that at lower position the straps have no slack so that straps support the arms rather than just the housing support the arms.**

Only the right side or NON motor side strap can be adjusted at the motor tube.

18 Install the wireless wall switch with the hardware provided. ***If the Automated WardrobeLift™ is installed inside a cabinet; please ensure the wireless, wall switch is mounted inside the cabinet. If wireless, wall switch is mounted out side the door, the switch may be activated inadvertently and could, potentially, cause damage to the cabinet door or the user when the door is opened to access the unit!***

19 See photo 9 and 10 for an example of an enclosure that can used to conceal the motor tube. The motor tube can also be painted or covered with wood grain contact paper.

Reset button must use pin, small screw or paperclip to activate. Beeps are very quiet!

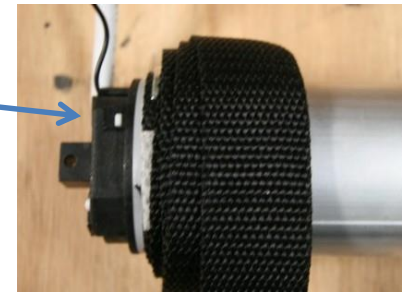

Trouble Shooting

PROBLEM	SOLUTION
Rotating arms are not stopping at proper points	Reset the motor limits using the wireless switch. See motor limit step in the instructions.
Lift does not respond or acts improperly. (Be sure to cut power and reconnect)	Press the reset button using a pin until 1 beep then immediately within 2 seconds press the up or down button on the switch. Unit should respond. If no response then proceed as follows. Press the reset button for approx. ten seconds using a pin. Hold until 2 beeps and release. Wait another 10 seconds or more then re-associate the motor to a switch by pressing the reset button once for 1 beep then immediately within 2 seconds press the Up or Down button of the switch.
Switch light out	Check battery
Lift does not go up straight	Adjust the right side strap which is the non motor side strap. Remove the anchor screw and move the strap material accordingly and then reinsert the screw. See installation instructions. The left side (Motor Head)strap CANNOT be adjusted.
Lift runs in reverse	Motor head needs to be on left side of tube when facing unit from the front. Lift the black cover on the switch and press the very small button on the right and hold for 3 seconds. Motor direction should now be changed
One switch operates two motors	Press the reset button (very small white button on the motor head) for ten seconds using a pin on the motor you want to disassociate. Hold until 3 beeps then release. Test all switches to make sure they will not operate the motor. Associate the motor to the correct switch by pressing the reset button once then immediately within 2 seconds pressing the Up or Down button of the correct switch. Make sure all other switches are not activated during this procedure. Set the motor limits.

Fig. 1

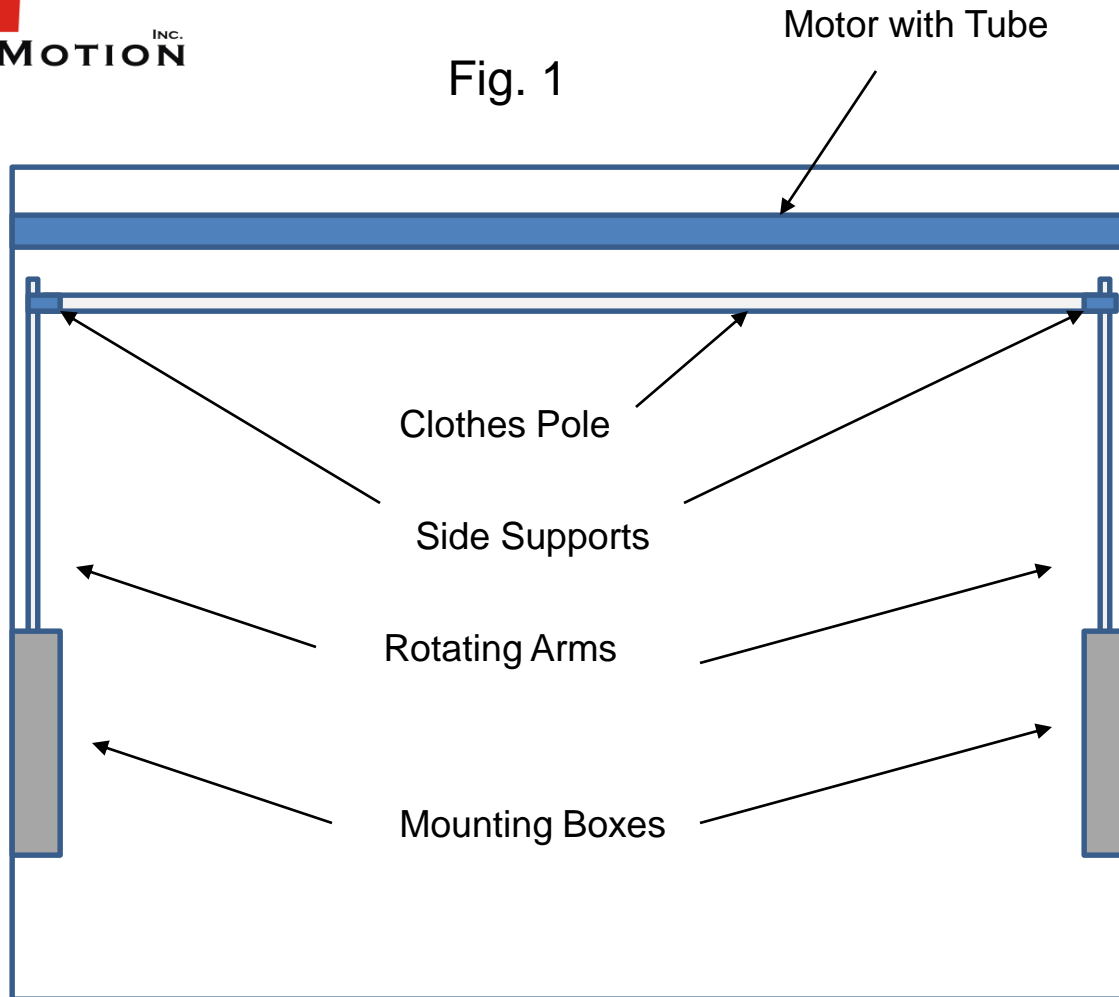

WARNING – Make sure the arms are mounted above the height of the user when in the down position



Motor with Tube

Fig. 2

Lifting Strap

Approx 1.5 to 3 in.

Approx 4 to 8 in.

Distance from the back of the closet to the clothes rail should be at least 11 inches .

Approx 9 inches

The motor tube and clothes rail can be mounted as close to the ceiling as desired

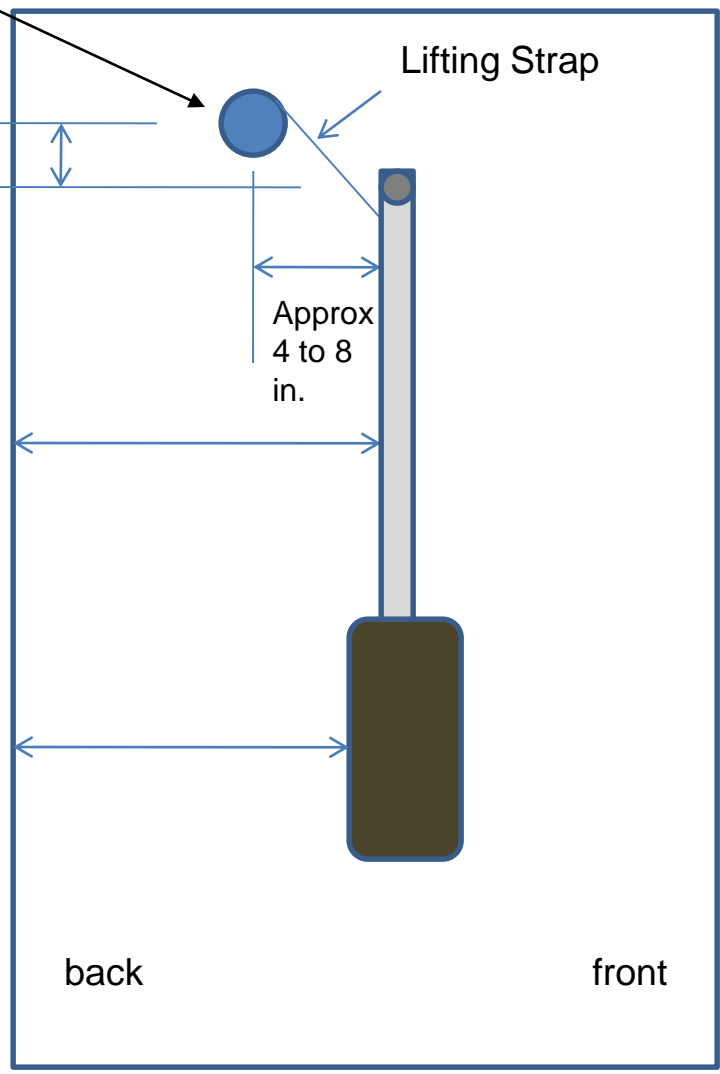

Right hand side view



WARNING – if motor is mounted too low it is possible to damage the unit when setting the the UP limit as too much leverage will be gained

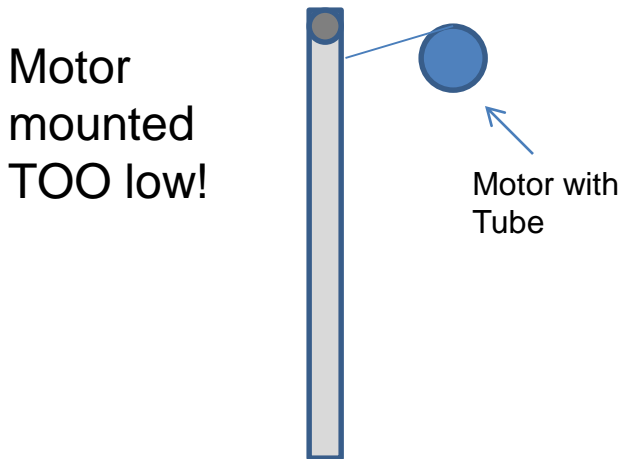
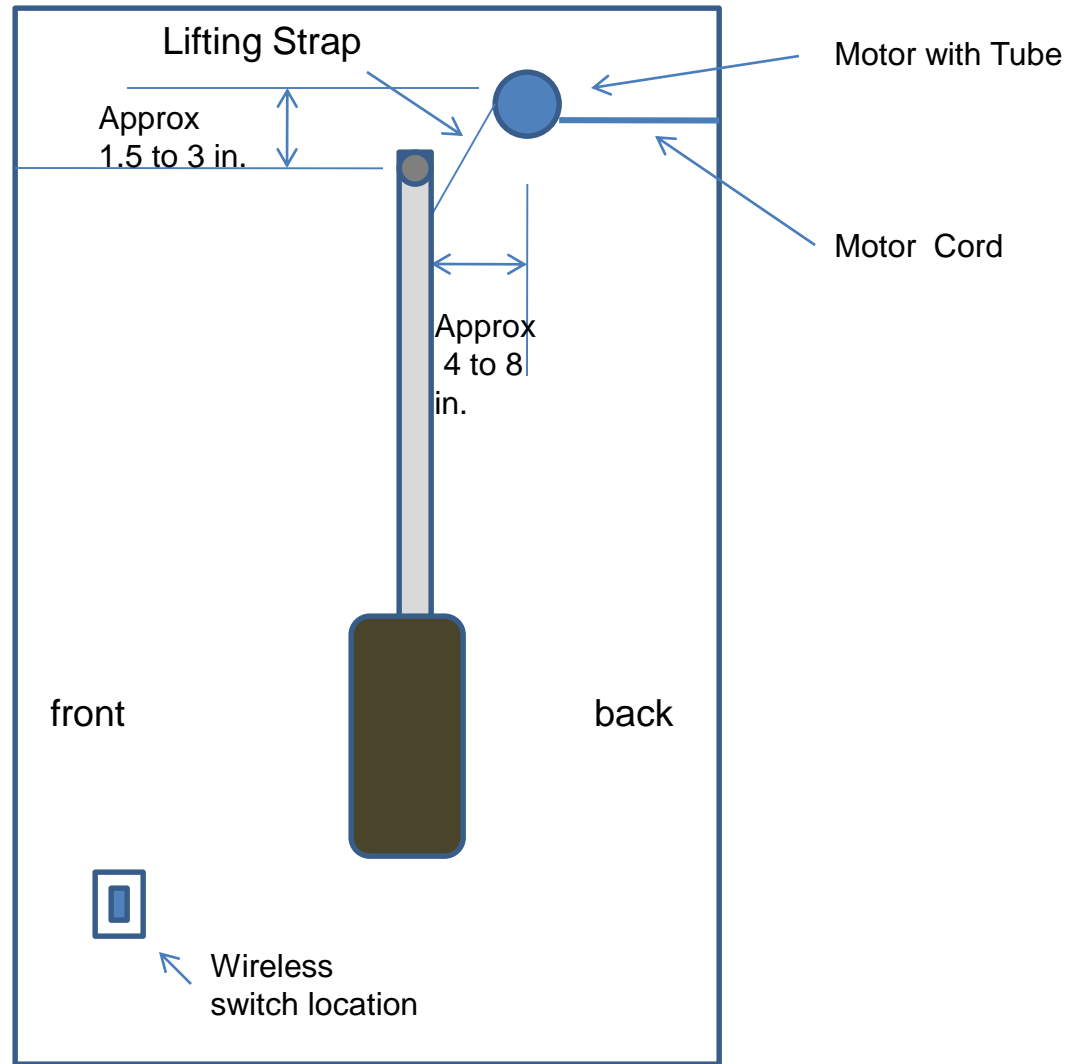

Fig. 3



Left hand side view

Patent Pending

Fig. 4

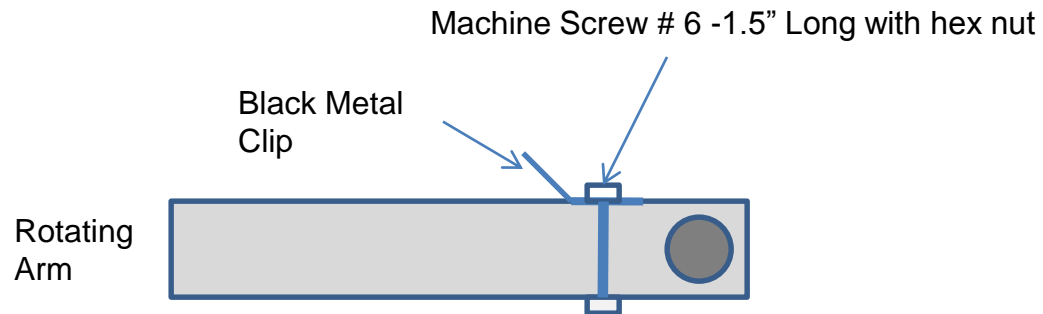

Photo 1



Photo 2

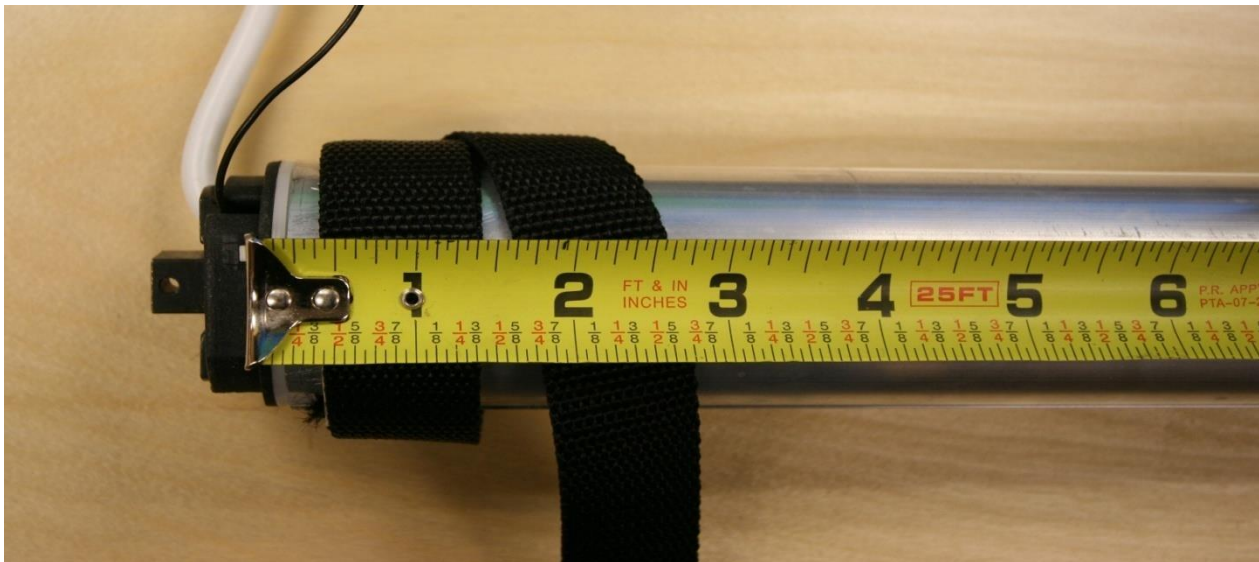

Photo 3



Photo 4

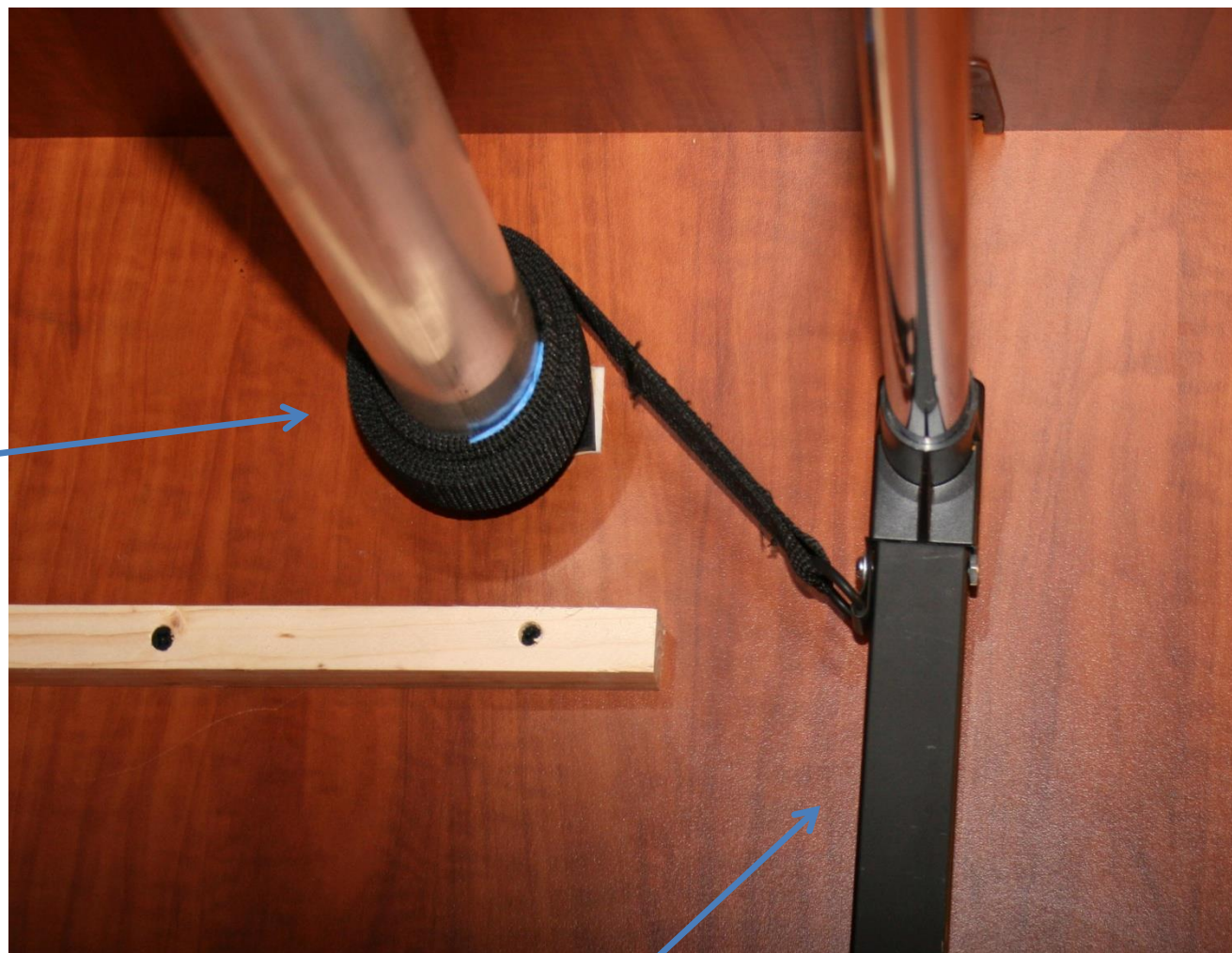

Photo 5



Photo 6

See
approximate
location of
motor tube in
relation to
rotating arm



Arm slightly
forward when
in up position

Patent Pending

Photo 7



Photo 8



Photo 9



Photo 10



Patent Pending